

EPS-SCHLISSANLAGENSYSTEM

Technische Informationen:

Doppelzylinder

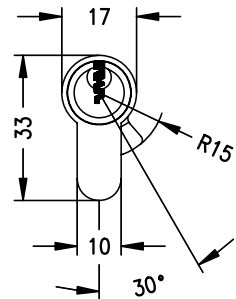
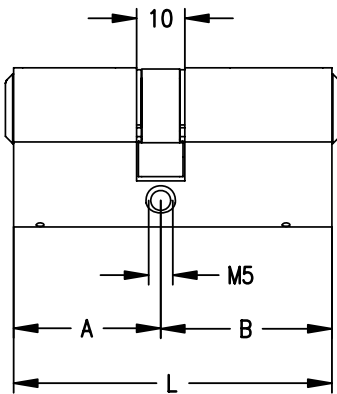

Zahnritzel ZR 10

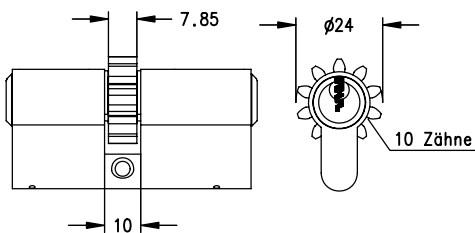

Zahnritzel ZR 18

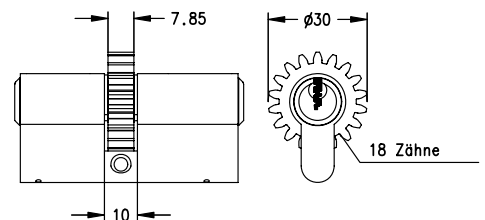

Knaufzylinder

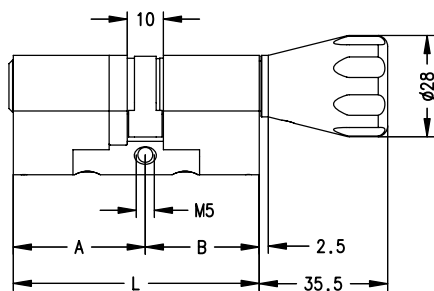

Halbzylinder

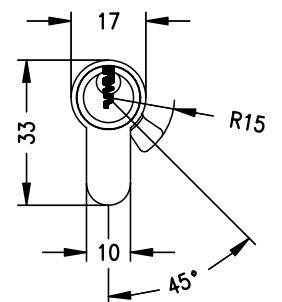
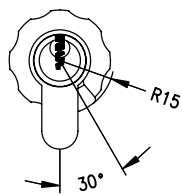
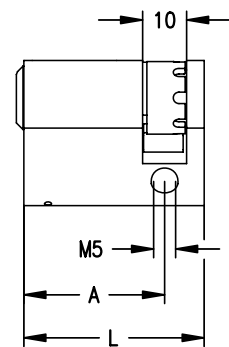

Schlüssel

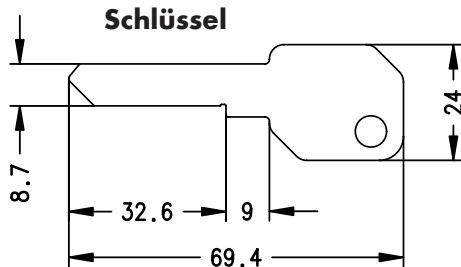

Staub- und Witterungsschuh

