



ETA-Danmark A/S  
Kollegievej 6  
DK-2920 Charlottenlund  
Tel. +45 72 24 59 00  
Fax +45 72 24 59 04  
Internet [www.etadanmark.dk](http://www.etadanmark.dk)

Authorised and notified according  
to Article 29 of the Regulation (EU)  
No 305/2011 of the European  
Parliament and of the Council of 9  
March 2011

MEMBER OF EOTA



## European Technical Assessment ETA-14/0105 of 14/05/2014

### I General Part

**Technical Assessment Body issuing the ETA and designated according to Article 29 of the Regulation (EU) No 305/2011: ETA-Danmark A/S**

**Trade name of the construction product:**

BB Purlin Ties

**Product family to which the above construction product belongs:**

Three-dimensional nailing plate (Purlin Tie for timber to timber connections)

**Manufacturer:**

BB Stanz- und Umformtechnik GmbH  
Nordhäuser Str. 42  
D-06536 Berga  
Tel. +49 34651 2988 0  
Fax +49 34651 2988 20  
Internet [www.bb-berga.de](http://www.bb-berga.de)

**Manufacturing plant:**

BB Stanz- und Umformtechnik GmbH  
Nordhäuser Str. 42  
D-06536 Berga

**This European Technical Assessment contains:**

17 pages including 2 annexes which form an integral part of the document

**This European Technical Assessment is issued in accordance with Regulation (EU) No 305/2011, on the basis of:**

Guideline for European Technical Approval (ETAG) No. 015 Three Dimensional Nailing Plates, April 2013, used as European Assessment Document (EAD).

**This version replaces:**

-

Translations of this European Technical Assessment in other languages shall fully correspond to the original issued document and should be identified as such.

Communication of this European Technical Assessment, including transmission by electronic means, shall be in full (excepted the confidential Annex(es) referred to above). However, partial reproduction may be made, with the written consent of the issuing Technical Assessment Body. Any partial reproduction has to be identified as such.

## II SPECIFIC PART OF THE EUROPEAN TECHNICAL ASSESSMENT

### 1 Technical description of product and intended use

#### Technical description of the product

BB Purlin ties right/left 170, 210, 250, 290, 330 and 370 and universal 170, 210, 250, 290, 330 and 370 are one-piece non-welded, face-fixed purlin ties to be used in timber to timber connections. They are connected to the timber elements by profiled nails.

The purlin ties are made from pre-galvanized steel S 250 GD + Z 275 according to EN 10346:2009.

Dimensions, hole positions and typical installations are shown in Annex A. Purlin ties are made from steel with tolerances according to EN 10143.

### 2 Specification of the intended use in accordance with the applicable EAD

The purlin ties are intended for use in making connections in load bearing timber structures, as a connection between a beam and a purlin, where requirements for mechanical resistance and stability and safety in use in the sense of the Basic Works Requirements 1 and 4 of Regulation (EU) 305/2011 shall be fulfilled.

The connection always contains two purlin ties (see Annex A).

The static and kinematic behaviour of the timber members or the supports shall be as described in Annex B.

The wood members may be of solid timber, glued laminated timber and similar glued members, or wood-based structural members with a characteristic density from 290 kg/m<sup>3</sup> to 420 kg/m<sup>3</sup>. This requirement to the material of the wood members can be fulfilled by using the following materials:

- Structural solid timber according to EN 14081,
- Glulam according to EN 14080,
- LVL according to EN 14374,
- Parallam PSL,
- Intrallam LSL,
- Cross laminated timber according to EN 16351 or ETA,
- Plywood according to EN 636

Annex B states the load-carrying capacities of the purlin tie connections for a characteristic density of 350 kg/m<sup>3</sup>.

For timber or wood based material with a different characteristic density than 350 kg/m<sup>3</sup> the load-carrying capacities of the nailed connection shall be modified by the  $k_{\text{dens}}$  factor:

$$k_{\text{dens}} = \sqrt{\frac{\rho_k}{350}}$$

Where  $\rho_k$  is the characteristic density of the timber in kg/m<sup>3</sup>.

The design of the connections shall be in accordance with Eurocode 5 or a similar national Timber Code. The wood members shall have a thickness which is larger than the penetration depth of the nails into the members.

The purlin ties made of pre-galvanized steel are primarily for use in timber structures subject to the dry, internal conditions defined by service class 1 and 2 of Eurocode 5 and for connections subject to static or quasi-static loading.

The purlin ties can also be used in outdoor timber structures, service class 3, when a corrosion protection in accordance with Euro Code 5 is applied, or when stainless steel with similar or better characteristic yield and ultimate strength is employed.

The scope of the purlin ties regarding resistance to corrosion shall be defined according to national provisions that apply at the installation site considering environmental conditions.

The provisions made in this European Technical Assessment are based on an assumed intended working life of the purlin ties of 50 years.

The indications given on the working life cannot be interpreted as a guarantee given by the producer or Assessment Body, but are to be regarded only as a means for choosing the right products in relation to the expected economically reasonable working life of the works.

### 3 Performance of the product and references to the methods used for its assessment

Characteristic	Assessment of characteristic
<b>3.1 Mechanical resistance and stability*) (BWR1)</b>	
Characteristic load-carrying capacity	See Annex B
Stiffness	No performance determined
Ductility in cyclic testing	No performance determined
<b>3.2 Safety in case of fire (BWR2)</b>	
Reaction to fire	The purlin ties are made from steel classified as Euroclass A1 in accordance with EN 1350-1 and EC decision 96/603/EC, amended by EC Decision 2000/605/EC
<b>3.3 Hygiene, health and the environment (BWR3)</b>	
Influence on air quality	No dangerous materials**)
<b>3.7 Sustainable use of natural resources (BWR7)</b>	
No Performance Determined	
<b>3.8 General aspects related to the performance of the product</b>	
The purlin ties have been assessed as having satisfactory durability and serviceability when used in timber structures using the timber species described in Eurocode 5 and subject to the conditions defined by service class 1 and 2	
Identification	See Annex A

\*) See additional information in section 3.9 – 3.12.

\*\*) In addition to the specific clauses relating to dangerous substances contained in this European technical Assessment, there may be other requirements applicable to the products falling within its scope (e.g. transposed European legislation and national laws, regulations and administrative provisions). In order to meet the provisions of the Construction Products Regulation, these requirements need also to be complied with, when and where they apply.

### 3.9 Methods of verification

#### Safety principles and partial factors

The characteristic load-carrying capacities are based on the characteristic values of the nail connections, the timber components and the steel plates. To obtain design values the capacities have to be multiplied with different partial factors for the material properties, the nailed connection and the timber components in addition with the coefficient  $k_{mod}$ .

According to EN 1990 (Eurocode – Basis of design) paragraph 6.3.5 the design value of load-carrying capacity can be determined by reducing the characteristic values of the load-carrying capacity with different partial factors.

Thus, the characteristic values of the load-carrying capacity are determined also for timber failure  $F_{Rk,H}$  (reaching the embedment strength of nails subjected to shear),  $F_{90,Rk}$  (reaching the transverse tensile strength of the timber components) as well as for steel plate failure  $F_{Rk,S}$ . The design value of the load-carrying capacity is the smaller value of both load-carrying capacities.

$$F_{Rd} = \min \left\{ \frac{k_{mod} \cdot F_{Rk,N}}{\gamma_{M,H}}; \frac{F_{Rk,S}}{\gamma_{M,S}}; \frac{k_{mod} \cdot F_{90,Rk}}{\gamma_{M,H}} \right\}$$

Therefore, for timber failure and the nailed connection the load duration class and the service class are included. The different partial factors  $\gamma_M$  for steel or timber, respectively, are also correctly taken into account.

#### 3.10 Mechanical resistance and stability

See annex B for the characteristic load-carrying capacity in the direction  $F_1$ .

The characteristic capacities of the purlin ties are determined by calculation assisted by testing as described in the EOTA Guideline 015 clause 5.1.2. They should be used for designs in accordance with Eurocode 5 or a similar national Timber Code.

*Threaded nails (ringed shank nails) in accordance to EN 14592*

In the formulas in Annex B the capacities for threaded nails calculated from the formulas of Eurocode 5 are used assuming a thick steel plate when calculating the lateral nail load-carrying-capacity.

The load bearing capacities of the brackets has been determined based on the use of connector nails 4,0 x 40 mm in accordance with the German national approval for the nails.

The characteristic withdrawal capacity of the nails has to be determined by calculation in accordance with EN 1995-1-1: 2004, paragraph 8.3.2 (head pull-through is not relevant):

$$F_{ax,Rk} = f_{ax,k} \times d \times t_{pen}$$

Where:

$f_{ax,k}$	Characteristic value of the withdrawal parameter in $N/mm^2$
$d$	Nail diameter in mm
$t_{pen}$	Penetration depth of the profiles shank in mm, $t_{pen} \geq 30$ mm

Based on tests by Versuchsanstalt für Stahl, Holz und Steine, University of Karlsruhe, the characteristic value of the withdrawal resistance for the threaded nails used can be calculated as:

$$f_{ax,k} = 6,125 \text{ N/mm}^2$$

The shape of the nail directly under the head shall be in the form of a truncated cone with a diameter under the nail head which exceeds the hole diameter.

4,0 mm threaded nails with a truncated cone below the head are used as fasteners, which are particularly suitable for nailed steel-to-timber connections. The specific shape below the head causes a clamping of nails in the steel plate.

No performance has been determined in relation to ductility of a joint under cyclic testing. The contribution to the performance of structures in seismic zones, therefore, has not been assessed.

No performance has been determined in relation to the joint's stiffness properties - to be used for the analysis of the serviceability limit state.

#### 3.11 Aspects related to the performance of the product

3.11.1 Corrosion protection in service class 1 and 2.

The joist hangers have a zinc coating weight of min Z275. The steel employed is S250 GD with min Z275 according to EN 10346:2009.

#### 3.12 General aspects related to the fitness for use of the product

The purlin ties are manufactured in accordance with the provisions of this European Technical Assessment using the manufacturing processes as identified in the

inspection of the plant by the notified inspection body and laid down in the technical documentation

The following provisions concerning product performance apply:

- The structural members to which the purlin ties are fixed shall be:
  - Restrained against rotation.
  - Solid timber according to EN 338 or better, see section 3 of this evaluation report
  - Free from wane under the purlin tie.
- The tensile perpendicular to the grain capacity of the timber member to be used in conjunction with the purlin tie is to be checked by the designer of the structure to ensure it is not less than the purlin tie capacity and, if necessary, the purlin tie capacity reduced accordingly.
- The gap between the timber members does not exceed 3 mm.
- There are no specific requirements relating to preparation of the timber members.

## **4 Attestation and verification of constancy of performance (AVCP)**

### **4.1 AVCP system**

According to the decision 97/638/EC of the European Commission, as amended, the system(s) of assessment and verification of constancy of performance (see Annex V to Regulation (EU) No 305/2011) is 2+.

## **5 Technical details necessary for the implementation of the AVCP system, as foreseen in the applicable EAD**

Technical details necessary for the implementation of the AVCP system are laid down in the control plan deposited at ETA-Danmark

Issued in Charlottenlund on 2014-05-14 by

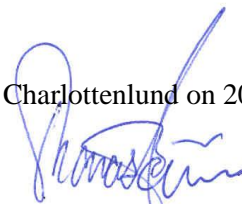

Thomas Bruun  
Managing Director, ETA-Danmark

## Annex A Product details

### Product details definitions

Table A.1 Materials specification

Purlin Ties Type	Thickness (mm)	Steel specification	Coating specification
<b>right/left (170-370)</b>	2,0	S 250 GD + Z 275	Z 275
<b>universal (170-370)</b>	2,0	S 250 GD + Z 275	Z 275

Table A.2 Dimensions

Purlin Ties Type	Length (mm)		Width (mm)	
	min	max	min	max
<b>right/left 170</b>	169	172	34	35
<b>right/left 210</b>	209	212	34,5	35,5
<b>right/left 250</b>	249	252	35,5	36,5
<b>right/left 290</b>	289	292	35,5	36,5
<b>right/left 330</b>	329	332	35,5	36,5
<b>right/left 370</b>	369	372	35,5	36,5
<b>universal 170</b>	169	172	34,5	35,5
<b>universal 210</b>	209	212	34,5	35,5
<b>universal 250</b>	249	252	34,5	35,5
<b>universal 290</b>	289	292	34,5	35,5
<b>universal 330</b>	329	332	34,5	35,5
<b>universal 370</b>	369	372	34,5	35,5

Table A.3 Fastener specification

Nail type	Nail size (mm)		Finish
	Diameter	Length	
According to EN 14592			
Threaded nail	4,0	40	Electroplated zinc

In the load-carrying-capacities of the nailed connection in Annex B the capacities for threaded nails calculated from the formulas of Eurocode 5 are used assuming a thick steel plate when calculating the lateral nail load-carrying-capacity.

The load-carrying-capacities of the purlin ties have been determined based on the use of connector nails 4,0 x 40 mm in accordance with the German national approval for the nails.

The characteristic withdrawal capacity of the nails has to be determined by calculation in accordance with EN 1995-1-1:2004, paragraph 8.3.2 (head pull-through is not relevant):

$$F_{ax,Rk} = f_{ax,k} \times d \times t_{pen}$$

Where:

$f_{ax,k}$  Characteristic value of the withdrawal parameter in N/mm<sup>2</sup>

$d$  Nail diameter in mm

$t_{pen}$  Penetration depth of the profiled shank including the nail point in mm,  $t_{pen} \geq 30$  mm

Based on tests by Versuchsanstalt für Stahl, Holz und Steine, Karlsruhe Institute of Technology, the characteristic value of the withdrawal resistance for the threaded nails used in timber with a characteristic density can be assumed as:

$$f_{ax,k} = 6,125 \text{ N/mm}^2$$

The shape of the nail directly under the head shall be in the form of a truncated cone with a diameter under the nail head which exceeds the hole diameter.



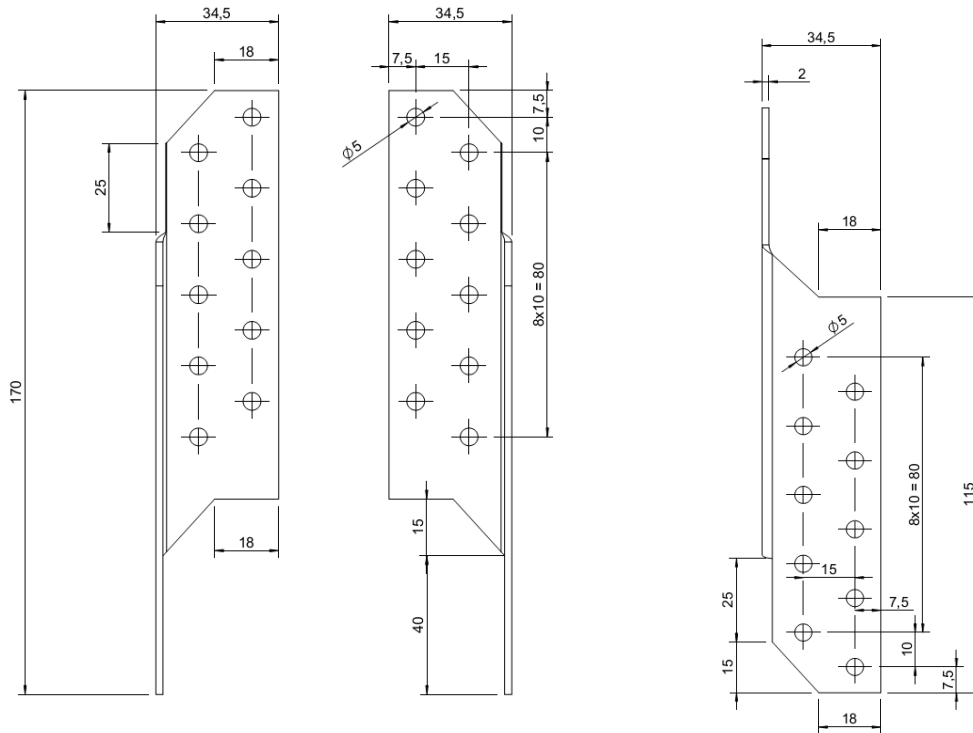

Figure A. 1 Dimensions of Purlin ties 170 right/left

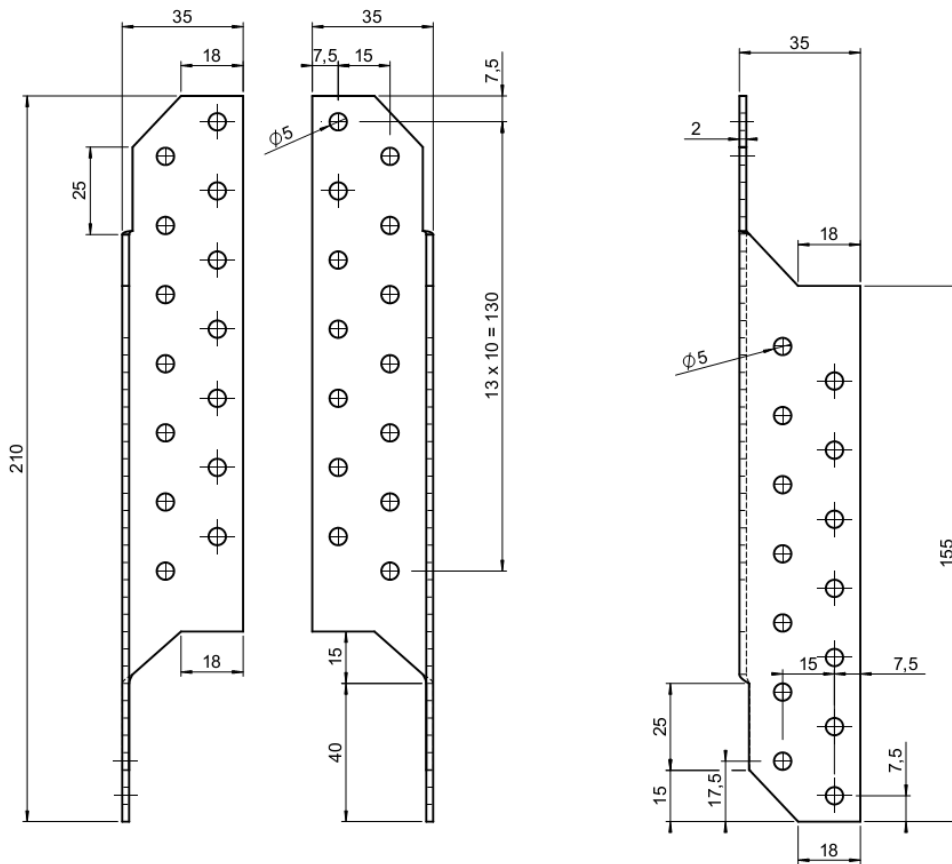

Figure A. 2 Dimensions of Purlin ties 210 right/left

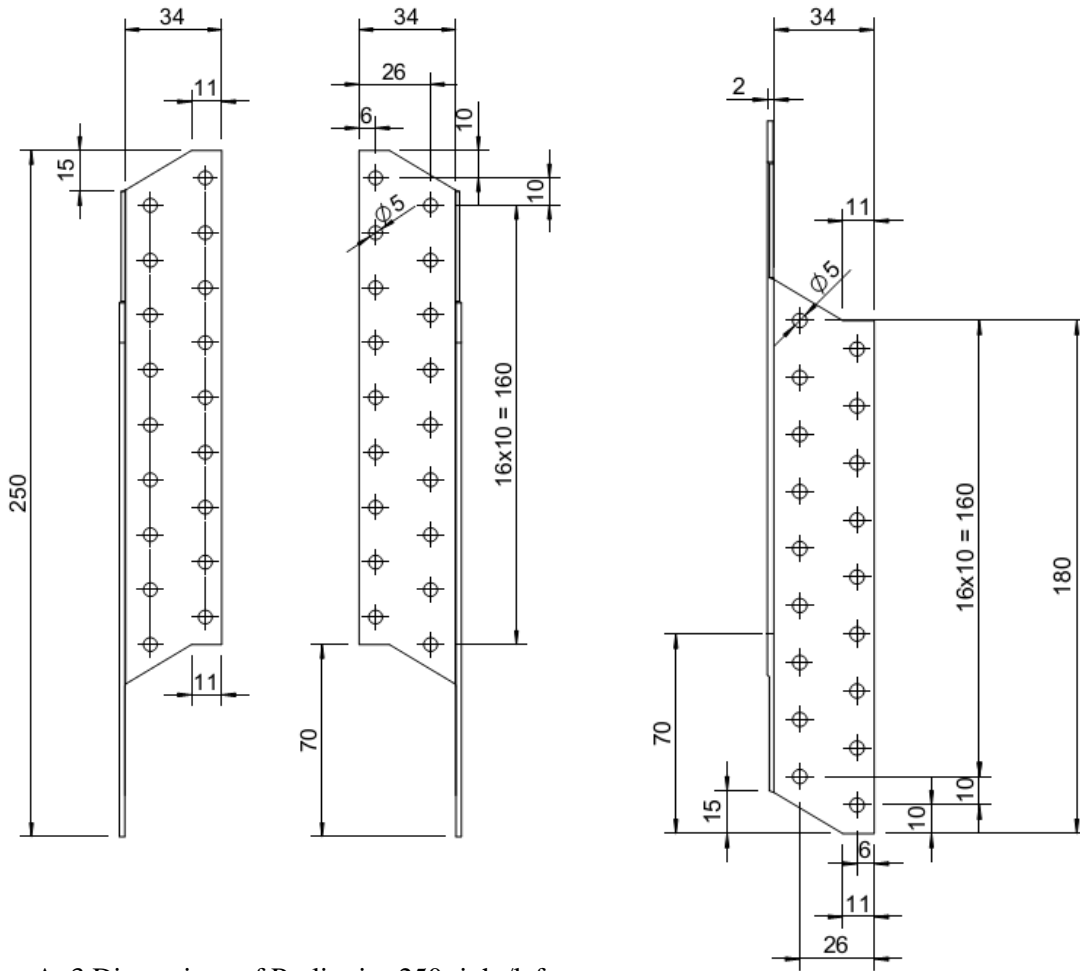

Figure A. 3 Dimensions of Purlin ties 250 right/left

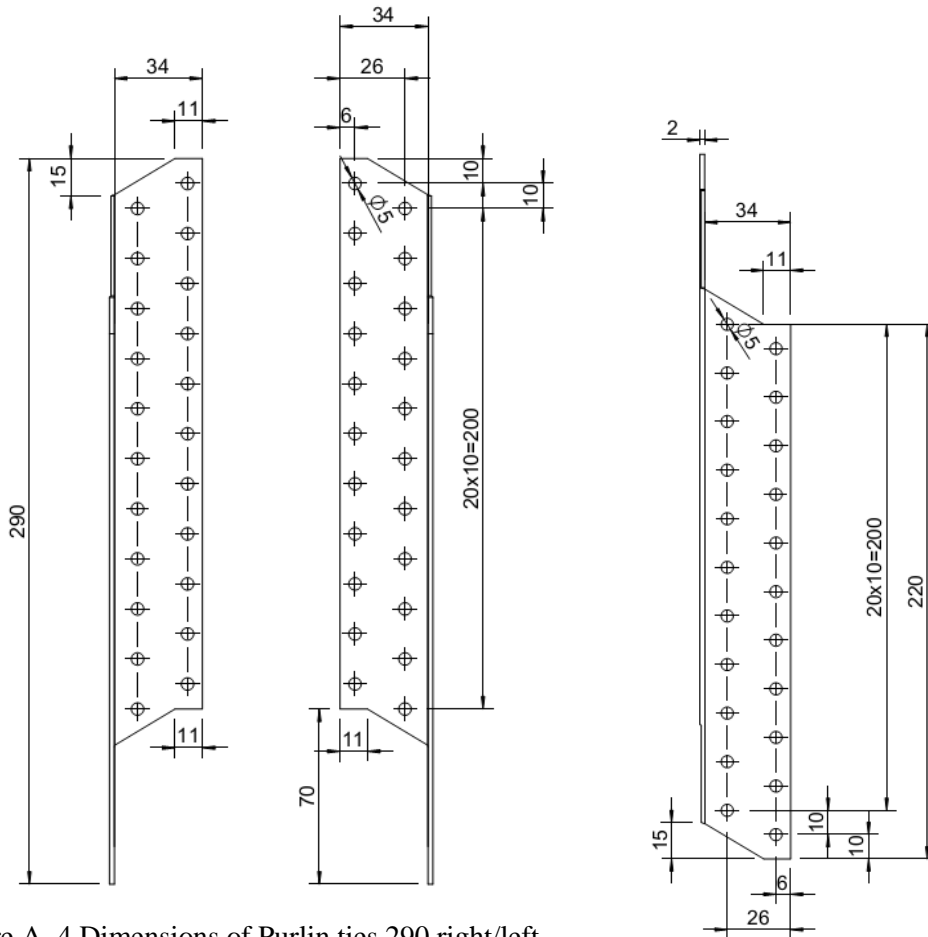

Figure A. 4 Dimensions of Purlin ties 290 right/left

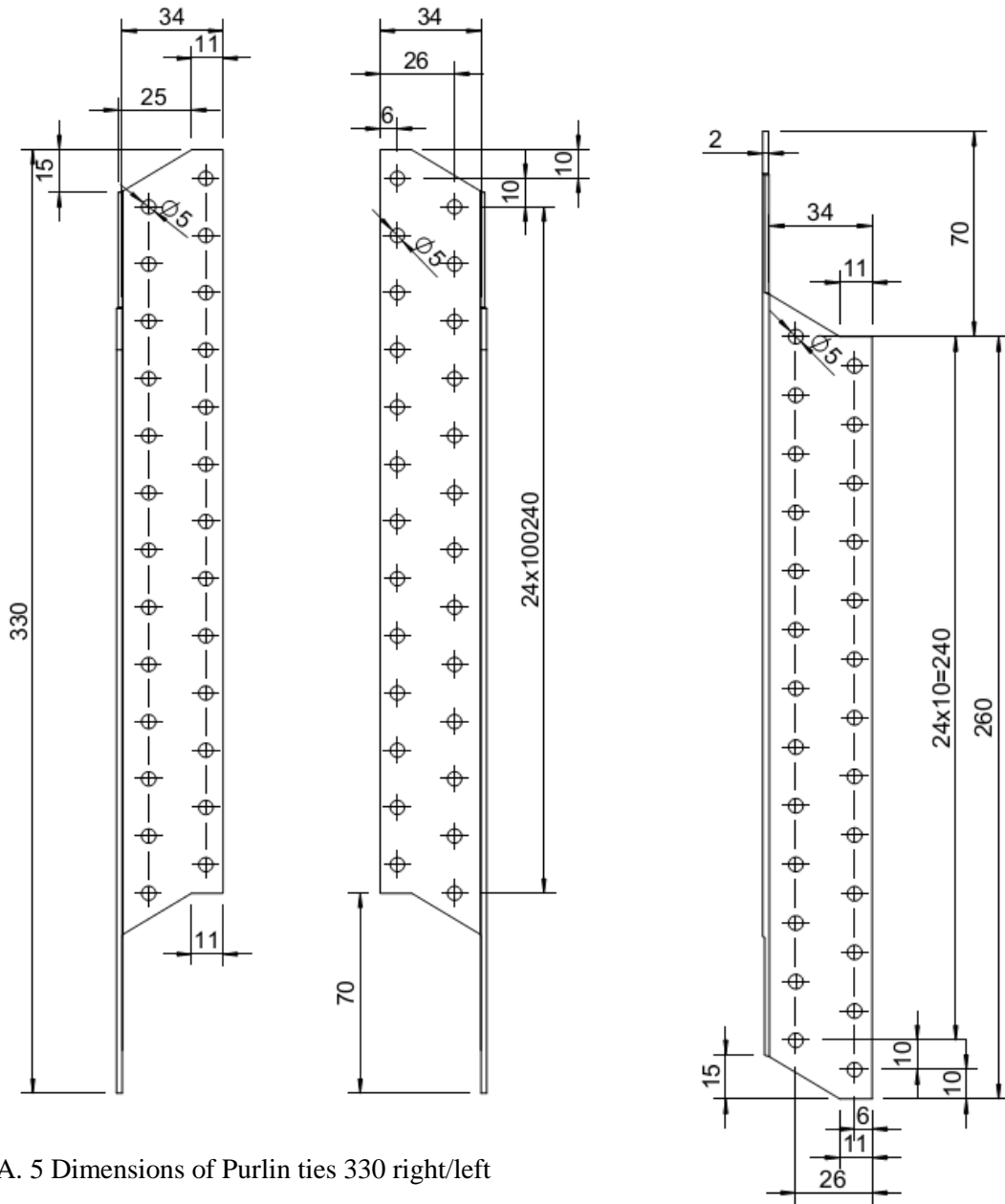

Figure A. 5 Dimensions of Purlin ties 330 right/left

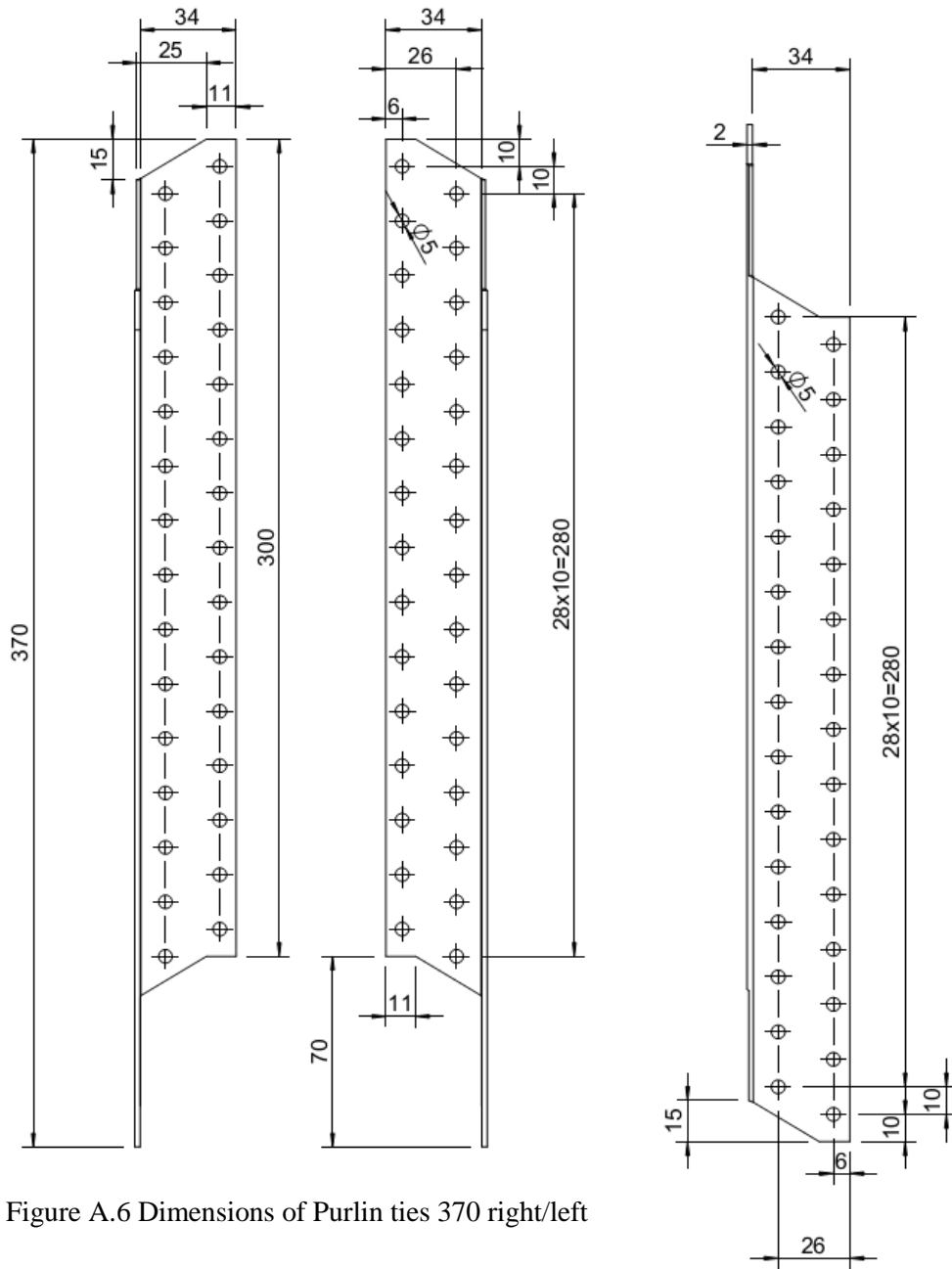

Figure A.6 Dimensions of Purlin ties 370 right/left

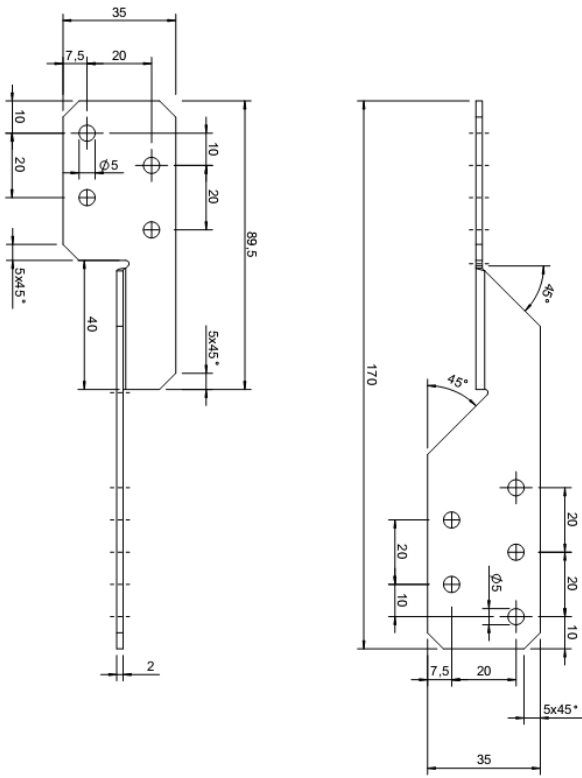

Figure A.7 Dimensions of Purlin ties 170 universal

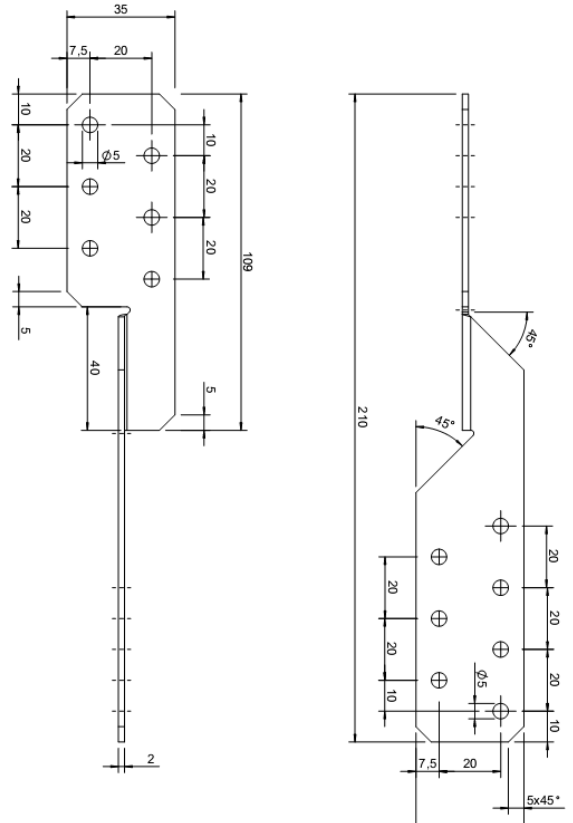

Figure A.8 Dimensions of Purlin ties 210 universal

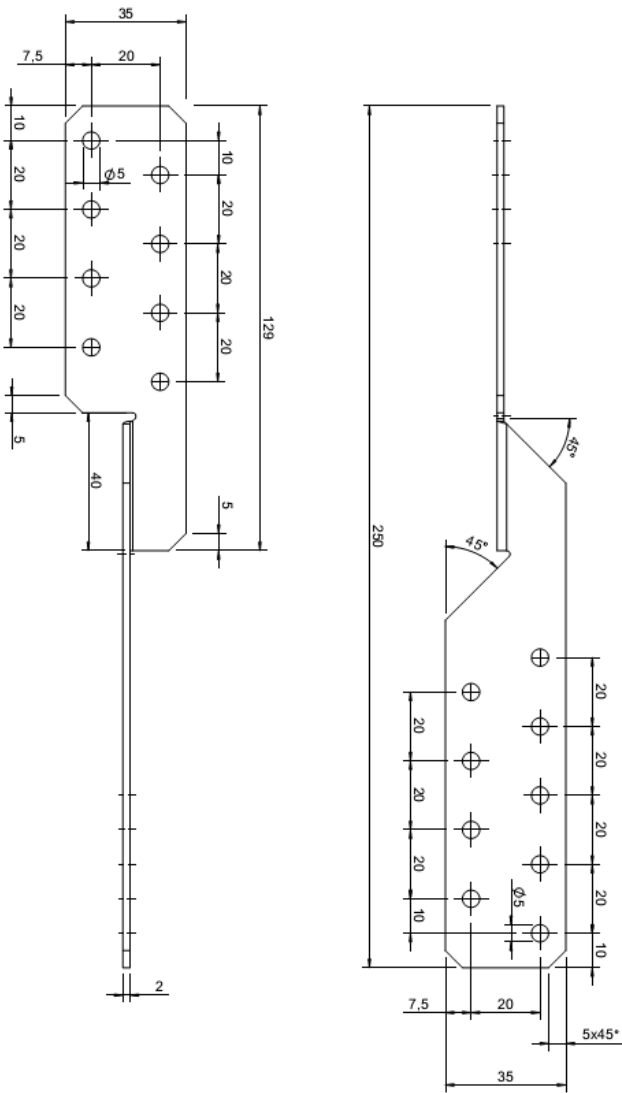

Figure A.9 Dimensions of Purlin ties 250 universal

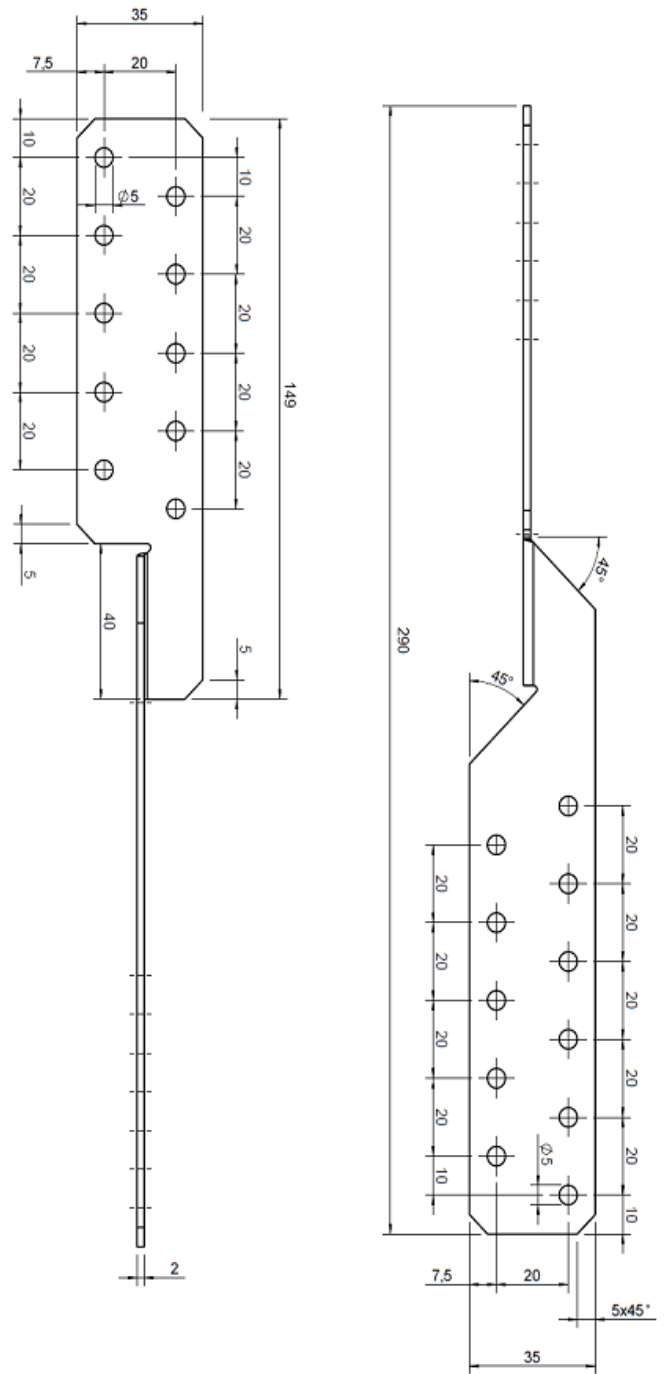

Figure A.10 Dimensions of Purlin ties 290 universal

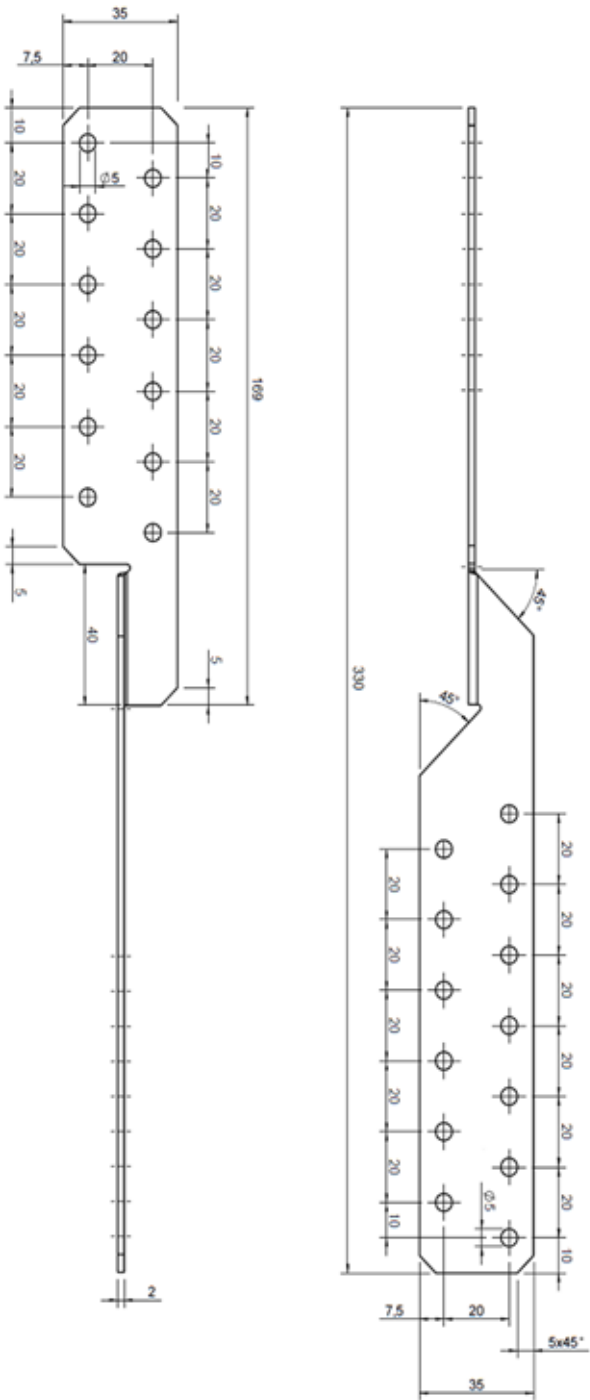

Figure A.11 Dimensions of Purlin ties 330 universal

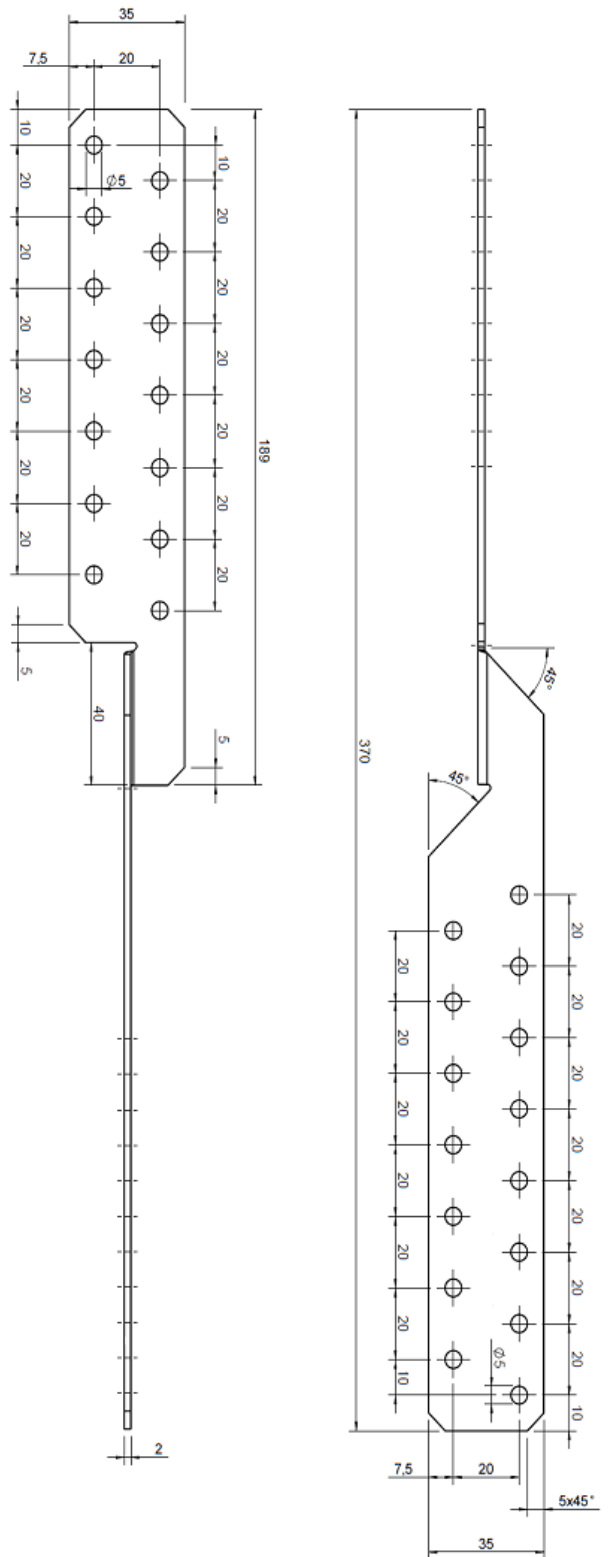

Figure A.12 Dimensions of Purlin ties 370 universal

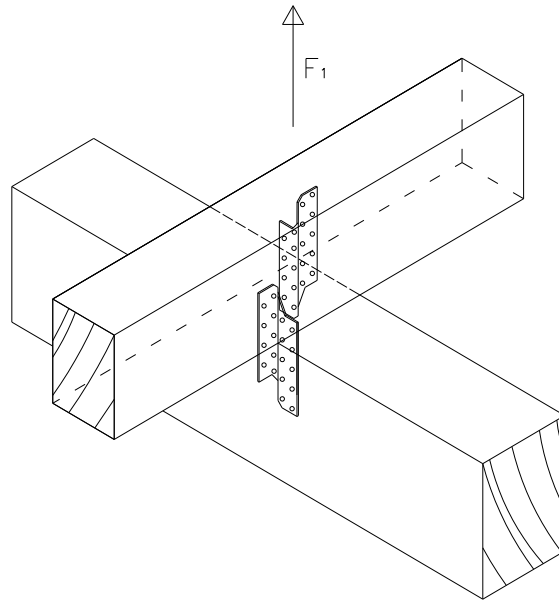

Figure A. 13 Typical installation



## Annex B

### Characteristic load-carrying capacities

#### Support conditions

The distance between the timber elements in the area of the connection must not exceed 3 mm. The timber members are prevented from rotation.

#### Fastener specification

The holes have to be nailed as given in Annex A, beginning at the end of the purlin tie.

#### Wane

Wane is not allowed, the timber has to be sharp-edged in the area of the purlin ties.

### Characteristic load-carrying capacities 2 purlin ties

**Table B.1:** Characteristic load-carrying capacities Load  $F_1$  – 2 Purlin Ties / connection in kN

Purlin Ties	Number of nails per Purlin Tie	Nailed connection $F_{Rk,N}$	Steel $F_{Rk,S}$	Transverse tensile failure
right/left 170	2 x 4	5,33	10,4	Design according to equation (B.1)
right/left 210	2 x 6	9,56	10,4	
right/left 250	2 x 8	14,9	10,4	
right/left 290	2 x 10	20,7	10,4	
right/left 330	2 x 12	27,0	10,4	
right/left 370	2 x 14	35,6	10,4	
universal 170	4 + 5	12,3	6,62	
universal 210	6 + 7	18,9	6,62	
universal 250	8 + 9	25,4	6,62	
universal 290	10 + 11	31,8	6,62	
universal 330	12 + 13	38,3	6,62	
universal 370	14 + 15	44,9	6,62	

#### Splitting

For a lifting force  $F_1$  splitting has to be proved, when necessary, for both timber elements. The capacity of a connection with two purlin ties on both sides of the timber element is calculated according to the general splitting design for connections with mechanical fasteners in EN 1995:2010.

$$F_{90,Rk} = 14 \cdot b \sqrt{\frac{h_e}{1 - \frac{h_e}{h}}} \quad (\text{B.1})$$

Where:

- $F_{90,Rk}$  the characteristic splitting capacity in N
- $b$  the member thickness, in mm
- $h_e$  is the loaded edge distance to the centre of the most distant fastener in mm
- $h$  the timber member height in mm

The design value of the force component perpendicular to the structural member's axis has to be lower than the design capacity  $F_{90,Rd}$ .